



GAS COMPONENTS



ELECTRIC COMPONENTS



WATER TECHNOLOGY



MECHANICAL COMPONENTS



TOOLS

Spare parts suitable for

LA CIMBALI

Find the complete and up-to-date range of products in our GEV Webshop



Manufacturer catalogue

The most important spare parts and accessories arranged clearly for every manufacturer

- ✓ Complete product range and all appliance data always up to date in the GEV Webshop
- ✓ Alphabetical Index at the end of the catalogue

GEV Webshop

www.gev-online.co.uk

www.gev-online.com







- 🔍 Add to Favourites
- 🔍 Sign In with email address and usual password
- 🔍 Easy-order – place several items in your basket at the same time
- 🔍 Quick Item search – no login needed





heating elements

heating elements for coffee machine



 <p>1</p>			
GEV No.	417014	Ref. No.	442-501-005 442-766-000
description	heating element 1300W 230V heating circuits 1 hole distance 59mm L 185mm W 40mm H 18mm hole ø 9mm tube ø 8.5mm connection male faston 6.3mm immersion heater 3 hole flange suitable for CIMBALI		
accessories for	417014		
	GEV No.	529484	Ref. No. 401-194-010
	 flat gasket fibre ED ø 58mm ID ø 50mm thickness 2mm Qty 1 pcs		

 <p>1</p>			
GEV No.	417011	Ref. No.	421-601-010 421601020 421-610-000 537-011-400 537-011-500 537-013-700
description	heating element 1800W 230V heating circuits 3 hole distance 59mm L 170mm W 34mm H 35mm hole ø 9.7mm thermostat sleeves ø 7mm length thermostat sleeves 170mm number of thermostat sleeves 1 thermostat sleeve eccentric, non clinging tube ø 8.5mm connection male faston 6.3mm immersion heater 3 hole flange suitable for CIMBALI		
accessories for	417011		
	GEV No.	528002	Ref. No. —
	 flat gasket PTFE ED ø 57mm ID ø 42mm thickness 3mm Qty 1 pcs equiv. no. 12001/W10470 suitable for		
	GEV No.	528488	Ref. No. —
	 flat gasket fibre ED ø 57mm ID ø 42mm thickness 3mm Qty 1 pcs		

 <p>1</p>			
GEV No.	417015	Ref. No.	N/A
description	heating element 2700W 230V heating circuits 1 mounting ø 54mm hole distance 55mm L 232mm W 35mm H 43mm hole ø 9mm thermostat sleeves ø 7mm length thermostat sleeves 230/240mm number of thermostat sleeves 2 thermostat sleeve not clinging tube ø 8.5mm connection M6x1 immersion heater 4 hole flange suitable for CIMBALI		
accessories for	417015		
	GEV No.	529496	Ref. No. N/A
	 gasket fibre D1 ø 54mm D2 ø 98mm thickness 3mm hole ø 6.7mm hole distance 55mm for heating element suitable for CIMBALI M15		

 <p>1</p>			
GEV No.	417013	Ref. No.	489-533-020 489-553-010 489-553-020 537-013-000 537-013-100
description	heating element 2850W 230/400V heating circuits 3 hole distance 59mm L 320mm W 27mm H 35mm hole ø 9mm tube ø 8.5mm connection male faston 6.3mm immersion heater 3 hole flange suitable for CIMBALI		



 <p>1</p>			
GEV No.	419158	Ref. No.	476-513-030
description	heating element 3750-4500W 220-240V heating circuits 3 hole distance 59mm L 380mm W 36mm H 37mm hole ø 9mm thermostat sleeves ø 6mm length thermostat sleeves 150mm number of thermostat sleeves 1 tube ø 8.4mm connection male faston 6.3mm immersion heater 3 hole flange suitable for CIMBALI		
accessories for	419158		
	GEV No.	529484	Ref. No. 401-194-010
	 flat gasket fibre ED ø 58mm ID ø 50mm thickness 2mm Qty 1 pcs		



 <p>1</p>			
GEV No.	417012	Ref. No.	476-513-020 537-011-600 537-012-100
description	heating element 3750W 220V heating circuits 3 hole distance 59mm L 315mm W 35mm H 41mm hole ø 9mm tube ø 8.1mm connection male faston 6.3mm immersion heater 3 hole flange suitable for CIMBALI		
accessories for	417012		
	GEV No.	528002	Ref. No. —
	 flat gasket PTFE ED ø 57mm ID ø 42mm thickness 3mm Qty 1 pcs equiv. no. 12001/W10470 suitable for		
	GEV No.	528488	Ref. No. —
	 flat gasket fibre ED ø 57mm ID ø 42mm thickness 3mm Qty 1 pcs		

 <p>1</p>			
GEV No.	420337	Ref. No.	802140217 984142000
description	heating element 3990W 230V heating circuits 3 mounting ø 40mm hole distance 59mm L 300mm W 31mm H 25mm hole ø 11mm length thermostat sleeves 210mm thermostat sleeves ø 7mm number of thermostat sleeves 1 thermostat sleeve eccentric, clinging tube ø 6.3mm connection male faston 6.3mm immersion heater 3 hole flange		

1 electric components





			
1			
GEV No.	417202	Ref. No.	911544000 911544010
description	heating element 4000W 230V heating circuits 3 mounting ϕ 42mm hole distance 74mm L 295mm W 34mm H 63mm L1 30mm L2 70mm L3 190mm H1 31mm H2 32mm hole ϕ 9mm tube ϕ 8.5mm thermostat sleeves ϕ 6.5mm length thermostat sleeves 199mm thermostat sleeve not clinging number of thermostat sleeves 1 connection male faston 6.3mm immersion heater 2 hole flange		
accessories for	417202		
	GEV No.	528022	Ref. No. —
	flat gasket PTFE ED ϕ 52mm ID ϕ 41mm thickness 2mm size 1 1/4" Qty 1 pcs suitable for CARIMALI, FAEMA, MARZOCCO, PAVONI		
	GEV No.	528488	Ref. No. —
	flat gasket fibre ED ϕ 57mm ID ϕ 42mm thickness 3mm Qty 1 pcs		

			
1			
GEV No.	417098	Ref. No.	N/A
description	heating element 5000W 220/380V heating circuits 3 hole distance 55mm L 355mm W 33mm H 33mm hole ϕ 9mm thermostat sleeves ϕ 6.5mm length thermostat sleeves 230/240mm number of thermostat sleeves 1 connection M6x1 immersion heater 4 hole fixing		
accessories for	417098		
	GEV No.	528005	Ref. No. —
	gasket fibre D1 ϕ 96mm D2 ϕ 56mm thickness 3.5mm hole ϕ 9mm hole distance 54mm		
	GEV No.	529496	Ref. No. N/A
	gasket fibre D1 ϕ 54mm D2 ϕ 98mm thickness 3mm hole ϕ 6.7mm hole distance 55mm for heating element suitable for CIMBALI M15		

			
1			
GEV No.	417099	Ref. No.	423504020 477-512-020 477512030 537-011-700 537-012-500
description	heating element 5790W 230V heating circuits 3 hole distance 59mm L 577mm W 35mm H 34mm hole ϕ 9.7mm thermostat sleeves ϕ 7mm length thermostat sleeves 170mm number of thermostat sleeves 1 thermostat sleeve not clinging tube ϕ 8mm connection male faston 6.3mm immersion heater 3 hole flange suitable for CIMBALI		

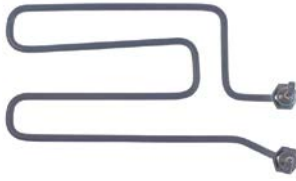
immersion heating elements

			
1			
GEV No.	418881	Ref. No.	802041007 984-087-000
description	heating element 2000W 230V heating circuits 1 L 245mm W 120mm H 25mm thread M12x1 mounting distance 45mm tube ϕ 6.3mm connection male faston 6.3mm 2 hole fixing connection length 25mm immersion heater tank		
accessories for	418881		
	GEV No.	504512	Ref. No. —
	O-ring EPDM thickness 1.78mm ID ϕ 14mm Qty 1 pcs		

accessories

sealing washers

fibre gaskets

			
1			
GEV No.	529484	Ref. No.	401-194-010
description	flat gasket fibre ED ϕ 58mm ID ϕ 50mm thickness 2mm Qty 1 pcs		

PTFE gaskets

			
1			
GEV No.	528004	Ref. No.	N/A
description	flat gasket PTFE ED ϕ 58mm ID ϕ 50mm thickness 2mm Qty 1 pcs suitable for CIMBALI		

O-rings

			
1			
GEV No.	550496	Ref. No.	401-178-002 401-178-012 402-226-000
description	O-ring Viton thickness 3.53mm ID ϕ 50.39mm Qty 1 pcs		

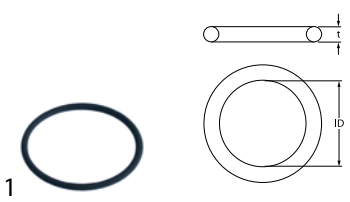
GEV No.	510245	Ref. No.	401-178-002
description	O-ring Viton thickness 3.53mm ID ø 50.8mm Qty 1 pcs		

flange gaskets



GEV No.	529496	Ref. No.	N/A
description	gasket fibre D1 ø 54mm D2 ø 98mm thickness 3mm hole ø 6.7mm hole distance 55mm for heating element suitable for CIMBALI M15		

thermostats

bi-metal thermostats

bi-metal thermostats



GEV No.	390503	Ref. No.	531101700
description	bi-metal thermostat hole distance 23.5mm switch-off temp. 135°C 1NC 1-pole 10A connection F6.3 2 hole fixing		

control and safety thermostats

EGO

safety thermostats

55.32_ series



GEV No.	390324	Ref. No.	531-193-100
description	safety thermostat switch-off temp. 169°C 3-pole 3NC 20A probe ø 4mm probe L 128mm capillary pipe 890mm capillary pipe isolated 210/210mm gland nut probe SS		

switches and momentary switches

microswitches

roller-lever actuated

with mounting components



GEV No.	346876	Ref. No.	819-410-208
description	microswitch with handle with a switch 250V 16A 1CO connection male faston L 35mm L1 28mm ambient temperature max. 125°C mounting distance 22mm type V-166-1CR5 actuating force: 86g		

pin-plunger actuated



GEV No.	344000	Ref. No.	532020000
description	microswitch with plunger 250V 15A 1CO connection male faston 6.3mm ambient temperature max. 105°C mounting distance 22mm actuating force: 340g white		

non-standard



GEV No.	347165	Ref. No.	802-041-002 802-131-735
description	microswitch complete incl. holder mounting distance 49mm 250V 16A 1NO connection male faston 6.3mm ambient temperature max. 125°C with plunger door contact switch actuating force: 140g 1-pole		

rotary switches

BREMAS

A1700 series



GEV No.	345149	Ref. No.	VG617500
description	rotary switch 3 0-1-2 sets of contacts 8 type CS0177121 400V 20A shaft ø 5x5mm shaft L 20mm shaft square connection screw		



			
1			
GEV No.	347879	Ref. No.	532005800
description	rotary switch 4 0-1-2-3 sets of contacts 4 type CS0176874 400V 16A shaft ø 5x5mm shaft L 21mm shaft square connection screw		

miscellaneous			
			
1			
GEV No.	346184	Ref. No.	532-004-300
description	rotary switch 0-1 type 80947-3 690V 16A shaft ø 5x5mm shaft L 22mm shaft square connection male faston 6.3mm 2 operating positions		

touch sensitive light switches			
			
1			
GEV No.	401950	Ref. No.	537035208
description	touch sensitive light switch		

lamps			
indicator lights			
indicator lights 2-piece (lens and indicator lamp)			
indicator light lenses			
ø12mm (type SDY-3)			
			
1			
GEV No.	359261	Ref. No.	530-106-200 530-106-400
description	indicator light housings mounting measurements ø12mm red round Qty 1 pcs		



timers

programme timers			
			
1			
GEV No.	360706	Ref. No.	802-140-010
description	timer CDC 4804M1 engines 1 chambers 4 operation time 120s 230V shaft ømm shaft Lmm manuf. no. 4804M10ADE000.1000		

relays

power relays			
with bracket mounting			
			
1			
GEV No.	380403	Ref. No.	3442-133-670 537-020-300
description	power relays FINDER 230VAC 16A 3CO connection F6.3 bracket mounting manuf. no. 62.83.8.230.0500		

electronics

PCBs			
			
1			
GEV No.	403440	Ref. No.	952846010
description	PCB coffee machine		
			
1			
GEV No.	401299	Ref. No.	918910008
description	PCB FAEMA series E97, E98 NA32		



keypads

membrane keypads

1 			
GEV No.	401657	Ref. No.	445005000
description	membrane keypad buttons 5		

1 			
GEV No.	403252	Ref. No.	422292000
description	membrane keypad espresso machine buttons 5 black suitable for M22 L 132mm W 32mm		

solenoid valves



solenoid valves (water)

metal

LUCIFER

2-way

7121ZBG series





1 				
GEV No.	370594 ¹	Ref. No.	533-798-310	
description	solenoid valve 2-ways 230VAC connection 1/8" L 30mm DN 2.5mm slide-on receptacle DIN -10 up to 140°C PARKER type series 7121ZBG coil type 483510S6 XS03XS6 F membranes FKM (water/steam) p max 10bar p min 0bar nickel-plated brass			
spare parts for	370594			
	GEV No.	371031	Ref. No.	—
	solenoid coil LUCIFER-PARKER 230VAC 9VA coil type DZ06S6 seat ø 15mm			
accessories for	370594			
	GEV No.	371090	Ref. No.	—
	power socket plug type DIN 43650A screw			







¹nickel-plated

3-way

131F series

1 				
GEV No.	370053	Ref. No.	533-795-610 533795610R	
description	solenoid valve 3-ways 230VAC DN 2.5mm slide-on receptacle DIN -10 up to 140°C type series 131F coil type DZ06S6 membranes FKM (water/steam) p max 10bar flange 32x32mm			
spare parts for	370053			
	GEV No.	370061	Ref. No.	CI0101
	solenoid valve body LUCIFER-PARKER 3-ways outer cone			

spare parts for	370053			
	GEV No.	371031	Ref. No.	—
	solenoid coil LUCIFER-PARKER 230VAC 9VA coil type DZ06S6 seat ø 15mm			
accessories for	370053			
	GEV No.	371090	Ref. No.	—
	power socket plug type DIN 43650A screw			
	GEV No.	371095	Ref. No.	—
	O-ring Viton thickness 1.78mm ID ø 6.07mm Qty 1 pcs			
	GEV No.	371100	Ref. No.	—
	O-ring silicone thickness 1.78mm ID ø 6.07mm Qty 1 pcs			

1 				
GEV No.	370054	Ref. No.	484074000	
description	solenoid valve 3-ways 24VAC DN 2.5mm slide-on receptacle DIN -10 up to 140°C type series 131F coil type DZ06P0 membranes FKM (water/steam) p max 10bar flange 32x32mm			
spare parts for	370054			
	GEV No.	370061	Ref. No.	CI0101
	solenoid valve body LUCIFER-PARKER 3-ways outer cone			
	GEV No.	371032	Ref. No.	—
	solenoid coil LUCIFER-PARKER 24VAC 9VA 50/60Hz coil type DZ06P0 seat ø 15mm			
accessories for	370054			
	GEV No.	371090	Ref. No.	—
	power socket plug type DIN 43650A screw			
	GEV No.	371095	Ref. No.	—
	O-ring Viton thickness 1.78mm ID ø 6.07mm Qty 1 pcs			
	GEV No.	371100	Ref. No.	—
	O-ring silicone thickness 1.78mm ID ø 6.07mm Qty 1 pcs			

131K series



1 				
GEV No.	370223	Ref. No.	533895400 533895400R	
description	solenoid valve 3-ways 230VAC connection 1/4" DN 2.5mm slide-on receptacle DIN -10 up to 140°C LUCIFER-PARKER type series 131K coil type DZ06S6 membranes ruby p max 10bar 50/60Hz			
spare parts for	370223			
	GEV No.	371031	Ref. No.	—
	solenoid coil LUCIFER-PARKER 230VAC 9VA coil type DZ06S6 seat ø 15mm			

Table continues overleaf

→ electric components



accessories for	370223			
	GEV No.	371090	Ref. No.	—
	power socket plug type DIN 43650A screw			

spare parts and accessories







valve bodies

	1		
GEV No.	370061	Ref. No.	CI0101
description	solenoid valve body LUCIFER-PARKER 3-ways outer cone		

PARKER

spare parts and accessories

valve bodies



	1			
GEV No.	370062	Ref. No.	CI0101	
description	solenoid valve body PARKER 3-ways outer cone			
accessories for	370062			
	GEV No.	371029	Ref. No.	—
	solenoid coil PARKER 230VAC 9VA coil type ZB09 seat ø 14mm H 33mm W 34mm D 43mm			
	GEV No.	371030	Ref. No.	—
	solenoid coil 24VDC 12VA coil type ZB12 seat ø 14mm			
	GEV No.	371033	Ref. No.	—
	solenoid coil PARKER 230VAC 9VA coil type YB09 with cable seat ø 14mm			
	GEV No.	371036	Ref. No.	—
	solenoid coil 24VAC 9VA coil type ZB09 seat ø 14mm			
	GEV No.	371095	Ref. No.	—
	O-ring Viton thickness 1.78mm ID ø 6.07mm Qty 1 pcs			
	GEV No.	371100	Ref. No.	—
	O-ring silicone thickness 1.78mm ID ø 6.07mm Qty 1 pcs			

pressure switches

for coffee machines

miscellaneous

	1		
GEV No.	541157	Ref. No.	537030700
description	pressure control		

	1			
GEV No.	541021	Ref. No.	CI0701	
description	pressure control pressure range adjustable 0.5-1.4bar connection 1/4" 30A 3-pole type P302 coffee machine parts SIRAI			
accessories for	541021			
	GEV No.	550262	Ref. No.	—
	flat gasket copper ED ø 20mm ID ø 14mm thickness 2mm			
	GEV No.	890100	Ref. No.	—
	PTFE tape reel L 12m W 12mm -200 up to +260°C approval DIN-DVGW, KTW temperature-resistant, elastic for fine thread thickness 0.1mm			

electrodes

	1		
GEV No.	401952	Ref. No.	537024900
description	level electrode M10 total length 125mm		



flow meters and flow sensors

flow meters

GICAR



1

GEV No.	403410	Ref. No.	534391800 534392300 534393100
description	flow controller thread 1/4" stainless steel coded approval NSF		

DIGMESA



1

GEV No.	402989	Ref. No.	534391020 534392400
description	flow controller thread 1/4" brass male faston 2.8mm approval NSF reducer ø 1mm		

motors

gear motors

for automatic coffee machines



1

GEV No.	500935	Ref. No.	484603000 537046100
description	gear motor CROUZET type 82861080 24V 5000rpm shaft ø 4mm L 65mm W 51mm H 61mm for outlet		



1

GEV No.	601607	Ref. No.	084518 819440059 N/A
description	motor 8W 230V voltage AC 50/60Hz 50/60rpm shaft ø 4mm L 70mm W 60mm H 110mm		

pumps

booster pumps II

pump motors

clip connection



1

GEV No.	500442	Ref. No.	530-290-800 530291000 530296900
description	motor RPM type 11002708 165W 230V 50/60Hz connection clip capacitor 10µF shaft ø 13mm		

pump heads

FLUID-O-TECH



1

GEV No.	501499	Ref. No.	537048400 537048500
description	pump head FLUID-O-TECH 180l/h connection 3/8" GAS		



1

GEV No.	500177	Ref. No.	533180100 533-196-900
description	pump head PA204X FLUID-O-TECH L 82mm 200l/h connection 3/8" GAS with filter an bypass brass clip connection for coffee machine shaft ø 4.8x11mm		



1

GEV No.	500290	Ref. No.	M31 Bistro
description	pump head V3797 PROCON L 82mm 100l/h connection 3/8" NPT with bypass brass clip connection for coffee machine shaft ø 4.8x11mm		





1

GEV No.	500064	Ref. No.	533-197-300
description	pump head PO204 FLUID-O-TECH L 82mm 200l/h connection 3/8" GAS with bypass brass clip connection for coffee machine shaft ø 4.8x11mm		
accessories for	500064		
	GEV No.	520126	Ref. No. —
clamp for pump/motor			

vibration pumps



1

GEV No.	500123	Ref. No.	442-544-002
description	vibration pump type 1106PAALM1N 230V 50Hz 70W inlet ø 1/8" IT outlet ø 1/8" IT outlet conical L 129mm FLUID-O-TECH		
accessories for	500123		
	GEV No.	371090	Ref. No. —
power socket plug type DIN 43650A screw			
	GEV No.	371120	Ref. No. —
diode type IN5408			
	GEV No.	390698	Ref. No. —
thermal fuse switch-off temp. 110°C suitable for ULKA pump			

PROCON



1

GEV No.	500934	Ref. No.	533197100
description	pump PROCON L 82mm 100l/h connection 3/8" NPT with filter brass clip connection for coffee machine shaft ø 4.8x11mm NSF		

pumps for milk foamers



1

GEV No.	500293	Ref. No.	N/A
description	pump head T1039 PROCON L 82mm 180l/h connection 3/8" NPT with bypass brass 3 hole flange for coffee machine shaft ø 3.5x7.5mm		

pumps



1

GEV No.	500933	Ref. No.	533198600
description	pump		



electric accessories

cables

accessories

cable glands

cable glands



1

GEV No.	550310	Ref. No.	532-123-500
description	cable gland ID \varnothing 5mm mounting \varnothing 7mm ED \varnothing 11mm Neoprene -30 up to +90°C Qty 10 pcs		

equipment-specific units

for espresso machines

filter holders

filter holders standard

filter holders (complete)



1

GEV No.	529243	Ref. No.	N/A	
description	filter holder 1-way suitable for without spring and filter ID \varnothing 61mm outlet distance mm			
accessories for	529243			
	GEV No.	529017	Ref. No.	N/A
	coffee filter \varnothing 68mm mounting \varnothing 59.5mm H 22mm cups 1 amount of coffee 7g			
	GEV No.	529018	Ref. No.	N/A
	coffee filter \varnothing 68mm mounting \varnothing 60mm H 18mm cups 1 amount of coffee 6g			
	GEV No.	529265	Ref. No.	—
	filter holder spring L 70mm W 62mm wire gauge \varnothing 1.2mm for espresso filter holder			
	GEV No.	529266	Ref. No.	—
	filter holder spring L 70mm W 62mm wire gauge \varnothing 1.1mm for espresso filter holder			



1

GEV No.	529244	Ref. No.	N/A	
description	filter holder 2-way suitable for without spring and filter ID \varnothing 61mm outlet distance 45mm			
accessories for	529244			
	GEV No.	529019	Ref. No.	N/A
	coffee filter \varnothing 68mm mounting \varnothing 60mm H 25mm cups 2 amount of coffee 14g			
	GEV No.	529020	Ref. No.	N/A
	coffee filter \varnothing 68mm mounting \varnothing 60mm H 22mm cups 2 amount of coffee 12g			
	GEV No.	529265	Ref. No.	—
	filter holder spring L 70mm W 62mm wire gauge \varnothing 1.2mm for espresso filter holder			
	GEV No.	529266	Ref. No.	—
	filter holder spring L 70mm W 62mm wire gauge \varnothing 1.1mm for espresso filter holder			

filter holder without spout



1

GEV No.	525980	Ref. No.	N/A
description	filter holder suitable for CIMBALI without outlet mounting \varnothing 81.4mm hole \varnothing 7mm ID \varnothing 61.5mm wedge height 13mm wedge position horizontal number of wedges 2 lever inclined		



1

GEV No.	525981	Ref. No.	N/A
description	filter holder suitable for CIMBALI without outlet mounting \varnothing 81mm outlet 3/8" ID \varnothing 61mm wedge height 12mm wedge position horizontal number of wedges 2 lever inclined		

filter holders short



GEV No.	529155	Ref. No.	N/A
description	filter holder		



GEV No.	529245	Ref. No.	N/A
description	filter holder mounting \varnothing 81.2mm outlet M16x1 ID \varnothing 60.5mm handle M10x1.5 wedge height 12.5mm wedge position horizontal number of wedges 2 lever inclined chrome-plated brass		



GEV No.	529051	Ref. No.	458-159-007
description	filter holder mounting \varnothing 81.4mm hole \varnothing 7mm outlet ID \varnothing 61.5mm handle M10x1.5 wedge height 13mm wedge position horizontal number of wedges 2 lever inclined		



GEV No.	530470	Ref. No.	458189007 537027420
description	filter holder mounting \varnothing 81mm hole \varnothing 7mm outlet ID \varnothing 58mm wedge height 7mm wedge position horizontal number of wedges 2 lever inclined chrome-plated brass		



GEV No.	530471	Ref. No.	457-239-007 458-159-027
description	filter holder mounting \varnothing 81mm hole \varnothing 7mm outlet ID \varnothing 58mm wedge height 7mm wedge position horizontal number of wedges 2 lever inclined chrome-plated brass		



GEV No.	529052	Ref. No.	457-305-007
description	filter holder mounting \varnothing 81mm outlet 3/8" ID \varnothing 61mm handle M10x1.5 wedge height 12mm wedge position horizontal number of wedges 2 lever inclined chrome-plated brass		



GEV No.	529154	Ref. No.	406-10-000
description	filter holder mounting \varnothing 82mm hole \varnothing 7mm ID \varnothing 61mm handle M10x1.5 wedge height 12.5mm wedge position diagonal number of wedges 2 lever straight chrome-plated brass		

handles

with external thread



GEV No.	529248	Ref. No.	537-021-900
description	handle \varnothing 37mm thread M10x1.5 thread L 11mm L 127mm black		

spouts

with thread 3/8"



GEV No.	529003	Ref. No.	N/A
description	filter holder spout thread 3/8" 1-way curved/long outlet distance mm thread L 5mm		



GEV No.	529007	Ref. No.	N/A
description	filter holder spout thread 3/8" 2-way curved/short outlet distance 45mm		

with thread M16x1



GEV No.	529246	Ref. No.	N/A
description	filter holder spout thread M16x1 1-way curved/long outlet distance mm		



			
1			
GEV No.	529247	Ref. No.	N/A
description	filter holder spout thread M16x1 2-way curved/short outlet distance 45mm		

without thread			
			
1			
GEV No.	529009	Ref. No.	N/A
description	filter holder spout 1-way outlet distance 45mm		

			
1			
GEV No.	529010	Ref. No.	N/A
description	filter holder spout 2-way outlet distance 40mm cups 2		

filters			
for 1 cup			
			
1			
GEV No.	529017	Ref. No.	N/A
description	coffee filter ø 68mm mounting ø 59.5mm H 22mm cups 1 amount of coffee 7g		

			
1			
GEV No.	529018	Ref. No.	N/A
description	coffee filter ø 68mm mounting ø 60mm H 18mm cups 1 amount of coffee 6g		

			
1			
GEV No.	531277	Ref. No.	457-232-000
description	coffee filter ø 69mm mounting ø 60mm H 18mm cups 1 amount of coffee 6g stainless steel		

for 2 cups			
			
1			
GEV No.	529020	Ref. No.	N/A
description	coffee filter ø 68mm mounting ø 60mm H 22mm cups 2 amount of coffee 12g		

			
1			
GEV No.	531278	Ref. No.	457-164-000 458-171-000
description	coffee filter ø 68mm mounting ø 60mm H 25.5mm cups 2 amount of coffee 14g		

			
1			
GEV No.	529019	Ref. No.	N/A
description	coffee filter ø 68mm mounting ø 60mm H 25mm cups 2 amount of coffee 14g		

			
1			
GEV No.	531279	Ref. No.	457-233-000
description	coffee filter ø 69mm mounting ø 60mm H 22mm cups 2 amount of coffee 12g		

brewing units			
shower screens			
flat			
			
1			
GEV No.	529084	Ref. No.	457504000
description	shower screen ø 52mm hole ø 6.4mm		

with upstand



1			
GEV No.	531275	Ref. No.	457560000
description	shower screen ø 58mm H 19mm		

screws



1			
GEV No.	560375	Ref. No.	503-705-200
description	countersunk screw thread M5 L 12mm SS DIN 963/ISO 2009 Qty 1 pcs intake slotted head ø 9mm old edition		

filter holder gaskets

flat

standard



1			
GEV No.	528035	Ref. No.	400-181-010
description	filter holder gasket D1 ø 71mm D2 ø 56.5mm H 8.5mm Qty 1 pcs		

with cone



1			
GEV No.	528036	Ref. No.	401-261-000 401-261-010
description	filter holder gasket with cone D1 ø 70.5mm D2 ø 56mm H1 8.9mm H2 5.8mm Qty 1 pcs		

components

nozzles

without thread



1			
GEV No.	527570	Ref. No.	931720000
description	nozzle bore ø 1.5mm L 33mm		

safety valves

safety valves

1/4"



1			
GEV No.	529307	Ref. No.	N/A
description	safety valve connection 1/4" triggering pressure 1.8bar		

drain valves



1			
GEV No.	530463	Ref. No.	419077000
description	drain fitting perforation ø 5mm		

aerators and air bleeders



1			
GEV No.	525329	Ref. No.	418911010 418941000 418941010 537-040-300
description	aerator and air bleeder connection 1/4" for boiler suitable for CIMBALI, FAEMA		



1			
GEV No.	529304	Ref. No.	418-911-002
description	aerator and air bleeder screw connection 1/4"		

boilers

heat exchangers

heat exchangers



1			
GEV No.	525635	Ref. No.	457-177-002 457-177-008
description	heat exchanger ø 42mm L 150mm for CIMBALI		



			
1			
GEV No.	525636	Ref. No.	457177005 457-177-006
description	heat exchanger ø 42mm L 210mm for CIMBALI		

steam/water taps

steam/water taps

steam taps

bodies

			
1			
GEV No.	530906	Ref. No.	485605000 485605010
description	tap body for M39 steam T1: 1/4" T2: 3/8" L 100mm		

components

gaskets

			
1			
GEV No.	529546	Ref. No.	400-274 010 400-274 020
description	gasket D1 ø 12mm D2 ø 4mm thickness 4mm Viton Qty 1 pcs		

			
1			
GEV No.	529539	Ref. No.	N/A
description	gasket D1 ø 15mm D2 ø 7mm thickness 4mm coffee machine		

tap bodies

			
1			
GEV No.	530547	Ref. No.	958572000 958572010
description	tap body T1: 1/4" T2: 3/8" L 99mm		

screws

			
1			
GEV No.	525350	Ref. No.	590791010
description	screw for water tap thread M4		

valve bodies

			
1			
GEV No.	525363	Ref. No.	485751000 485751010 485910010
description	valve body for steam-/water-tap		

steam/water pipes

steam pipes

			
1			
GEV No.	529887	Ref. No.	485-524-000 485612000 485612010
description	steam pipe		

			
1			
GEV No.	529885	Ref. No.	485949020 485949030 485949040 485949050
description	steam pipe IT 3/8"		

nozzles for water pipes

tap aerators



1

GEV No.	529886	Ref. No.	4771134699 532305000
----------------	--------	-----------------	-------------------------

description tap aerator D1 ø 19mm H 13mm

level glasses

level glasses

gaskets



1

GEV No.	529427	Ref. No.	400-275-000 400275010
----------------	--------	-----------------	--------------------------

description gasket D1 ø 13mm D2 ø 17.5mm ID ø 11mm H 9mm rubber water level glass suitable for PAVONI

pressure rings



1

GEV No.	529547	Ref. No.	419-072-000
----------------	--------	-----------------	-------------

description press ring ID ø 9/11mm H 3.5mm thickness 1.3mm

housings



1

GEV No.	525779	Ref. No.	4831132157
----------------	--------	-----------------	------------

description tray for water level tube plastic suitable for FAEMA

level glasses



1

GEV No.	529365	Ref. No.	4831130683
----------------	--------	-----------------	------------

description level glass L 89mm W 30mm thickness 3.5mm for water level tube polycarbonate

pipes

pipes



1

GEV No.	531142	Ref. No.	496937010
----------------	--------	-----------------	-----------

description drain pipe ø 6mm L 170mm T1: 1/8" for espresso machine

miscellaneous



1

GEV No.	690738	Ref. No.	534193400
----------------	--------	-----------------	-----------

description catch



1

GEV No.	530548	Ref. No.	533.001.200
----------------	--------	-----------------	-------------

description level electrode ø 2.5mm L 154mm

for coffee grinders

grinding burrs

grinding burrs straight

standard



1

GEV No.	527223	Ref. No.	4801-116 730
----------------	--------	-----------------	--------------

description grinding burrs pair turn direction right D1 ø 54mm ID ø 31mm H 8mm tooth spacing 3.5mm hole ø 4.5mm bore ø 6.5mm mounting ø 45 straight suitable for FAEMA (MP,MPN)





			
1			
GEV No.	527218	Ref. No.	N/A
description	grinding burrs pair turn direction right D1 ø 54mm ID ø 32mm H 9mm tooth spacing 3.5mm hole ø 6mm bore ø 8.5mm mounting ø 41 straight suitable for CIMBALI		

			
1			
GEV No.	527219	Ref. No.	535-100-200
description	grinding burrs pair turn direction right D1 ø 64mm ID ø 37mm H 8.5mm tooth spacing 3mm hole ø 5.5mm bore ø 8.5mm mounting ø 50 straight suitable for DRM, CIMBALI		



			
1			
GEV No.	527220	Ref. No.	803-130-050
description	grinding burrs pair turn direction right D1 ø 68mm ID ø 43mm H 8mm tooth spacing 5mm hole ø 5mm bore ø 8mm mounting ø 54 straight suitable for DRM, CIMBALI		

<h3>spillage trays</h3>			
			
1			
GEV No.	531195	Ref. No.	4529-134-772
description	drain tray L 157mm W 159mm suitable for CIMBALI		

<h3>dosing containers</h3>			
<h4>automatic grinding</h4>			
<h4>automatic grinding</h4>			
			
1			
GEV No.	698757	Ref. No.	4529-133-522
description	housing for microswitch H 26mm L 102mm		
accessories for	698757		
			
GEV No.	698756	Ref. No.	4529133521 800-133-521
description	lid for microswitch H 20mm		

			
1			
GEV No.	698756	Ref. No.	4529133521 800-133-521
description	lid for microswitch H 20mm		

<h3>for cup coffee machines</h3>			
<h4>coffee spouts</h4>			
<h4>coffee spouts</h4>			
			
1			
GEV No.	527568	Ref. No.	431320020 431320030
description	coffee spout suitable for CIMBALI		
accessories for	527568		
			
GEV No.	527569	Ref. No.	431321000 931764000
description	lid set for outlet		

			
1			
GEV No.	527569	Ref. No.	431321000 931764000
description	lid set for outlet		
accessories for	527569		
			
GEV No.	527568	Ref. No.	431320020 431320030
description	coffee spout suitable for CIMBALI		

for dishwashers

washing and rinsing systems



1	GEV No.	510194	Ref. No.	984219000
	description	swirl		

knobs

producer-specific knobs

CIMBALI



1	GEV No.	112005	Ref. No.	421-920-002	
	description	knob switch zero mark t.max.°C° 45mm shaft ø 5x5mm shaft flat black			
	accessories for	112005			
		GEV No.	112006	Ref. No.	544-400-230
		knob spring L 8.8mm W 5mm H 7.7mm			

accessories

button springs



1	GEV No.	111062	Ref. No.	544-400-270
	description	knob spring L 20mm W 10mm H 11.5mm		



1	GEV No.	112006	Ref. No.	544-400-230
	description	knob spring L 8.8mm W 5mm H 7.7mm		

handles and hand wheels

lever handles



1	GEV No.	112859	Ref. No.	911564000SX 911564010
	description	slide mounting pos. left		



1	GEV No.	111450	Ref. No.	911563000DX
	description	slide mounting pos. right		

gaskets

O-rings

EPDM

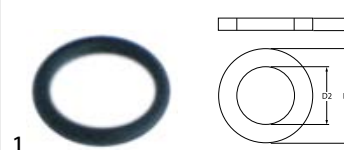

1	GEV No.	510177	Ref. No.	402-223-000
	description	O-ring EPDM thickness 1.78mm ID ø 7.66mm Qty 1 pcs		



1	GEV No.	529412	Ref. No.	400-279 000
	description	O-ring EPDM thickness 2.62mm ID ø 10.78mm Qty 1 pcs		

Viton

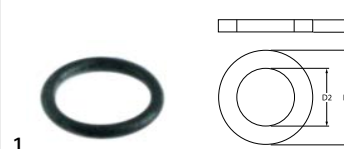

1	GEV No.	532414	Ref. No.	402-209-000
	description	O-ring Viton thickness 1.78mm ID ø 10.82mm Qty 10 pcs		

GEV No.	528687	Ref. No.	402250000
description	O-ring Viton thickness 1.78mm ID ø 3.69mm Qty 1 pcs		

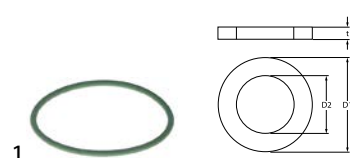

GEV No.	532524	Ref. No.	402241000
description	O-ring Viton thickness 1.78mm ID ø 35mm Qty 1 pcs		



GEV No.	532408	Ref. No.	402249000
description	O-ring Viton thickness 1.78mm ID ø 5.28mm Qty 10 pcs		



GEV No.	532426	Ref. No.	402197000
description	O-ring Viton thickness 2.62mm ID ø 9.13mm Qty 10 pcs		



GEV No.	550496	Ref. No.	401-178-002 401-178-012 402-226-000
description	O-ring Viton thickness 3.53mm ID ø 50.39mm Qty 1 pcs		



GEV No.	510245	Ref. No.	401-178-002
description	O-ring Viton thickness 3.53mm ID ø 50.8mm Qty 1 pcs		

sealing washers

fibre gaskets



GEV No.	529484	Ref. No.	401-194-010
description	flat gasket fibre ED ø 58mm ID ø 50mm thickness 2mm Qty 1 pcs		

rubber gaskets



GEV
Image not available

GEV No.	698758	Ref. No.	400-182-000
description	flat gasket EPDM ED ø 60.5mm ID ø 48.5mm thickness 5mm		



GEV No.	520390	Ref. No.	4701134698
description	flat gasket rubber ED ø 21mm ID ø 16mm thickness 2mm Qty 1 pcs		

PTFE gaskets



GEV No.	525304	Ref. No.	401183000 401183010
description	flat gasket PTFE ED ø 22mm ID ø 17mm thickness 1.5mm Qty 1 pcs		



GEV No.	528004	Ref. No.	N/A
description	flat gasket PTFE ED ø 58mm ID ø 50mm thickness 2mm Qty 1 pcs suitable for CIMBALI		

special gaskets

group gaskets



GEV No.	528126	Ref. No.	N/A
description	group gasket D1 ø 94mm thickness 2mm		

miscellaneous



1			
GEV No.	528092	Ref. No.	401-247-000
description	piston gasket ED ø 53mm ID ø 46mm		

springs

compression springs



1			
GEV No.	530358	Ref. No.	430013010
description	compression spring ø 6.1mm L 15mm wire gauge ø 1.1mm		

manometers



1			
GEV No.	541210	Ref. No.	N/A
description	manometer double scale ø 63mm pressure range 0-2.5 / 0-15bar connection on the backside thread 1/8"		



1			
GEV No.	541211	Ref. No.	421-127-000
description	manometer double scale ø 63mm pressure range 0-2.5 / 0-15bar connection on the backside thread 1/8"		



1			
GEV No.	541206	Ref. No.	3781-133-399
description	manometer ø 42mm pressure range 0 up to 16bar thread 1/8" marking 12 connection on the backside		



1			
GEV No.	541213	Ref. No.	496-246-000
description	manometer ø 57mm pressure range 0 up to 15bar thread 1/8" marking 8-10 connection on the backside		



1			
GEV No.	541212	Ref. No.	450-009-000 450-524-000 475-094-010 475-137-010
description	manometer ø 57mm pressure range 0 up to 2.5bar thread 1/8" connection on the backside		



1			
GEV No.	541275	Ref. No.	N/A
description	manometer ø 57mm pressure range 0 up to 2.5bar thread 1/8" marking 1.6 connection on the backside		



1			
GEV No.	541276	Ref. No.	N/A
description	manometer ø 57mm pressure range 0 up to 2.5bar thread 1/8" marking 1.6 connection on the backside		



1			
GEV No.	525645	Ref. No.	445-029-000
description	manometer ø 57mm pressure range 0-16bar CARIMALI connection 1/8"		



			
1			
GEV No.	525644	Ref. No.	445-028-000
description	manometer ø 57mm pressure range 0-2.5bar without glass connection 1/8"		

dosing pumps

membrane dosing pumps

self-priming

various



			
1			
GEV No.	361015	Ref. No.	802-191-002 984125000
description	dosing pump membrane dosing pump rinse aid inlet 6x8mm outlet 4x6mm pressure connection ø 4x6mm suction connection ø 6x8mm		
spare parts for	361015		
	GEV No.	Ref. No.	
	361132	—	—
	membrane dosing pump		
	GEV No.	Ref. No.	
	510298	—	—
	lip valve dosing pump suitable for DB2/DS5		

hoses

supply hoses

stainless steel flexi hoses

universal hoses

			
1			
			
GEV No.	520611	Ref. No.	532302000
description	flex hose SS braid straight-straight DN6 connections 1/8" L 600mm approval DVGW operating p. 10bar test pressure 32bar burst p. 95bar		

industrial hoses

PTFE hoses

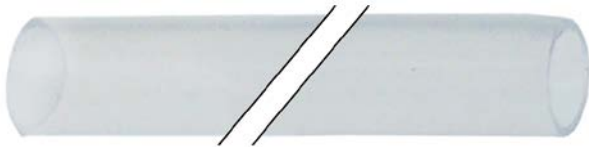
			
1			
GEV No.	520389	Ref. No.	220000021
description	PTFE hose ø 2x4mm L 2000mm		

silicone hoses

without fabric

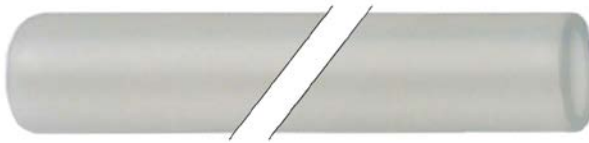
			
1			
GEV No.	520388	Ref. No.	484391000
description	silicone hose ID ø 5mm ED ø 8mm L 1m thickness 1.5mm operating pressure without pressure burst pressure non defined t.max. 200°C		

fittings, hose and pipe connectors

hose connectors

miscellaneous

			
1			
GEV No.	527571	Ref. No.	532652000
description	tube connector angled connection 4mm		

fastening material

screws

countersunk screws

			
1			
GEV No.	560375	Ref. No.	503-705-200
description	countersunk screw thread M5 L 12mm SS DIN 963/ISO 2009 Qty 1 pcs intake slotted head ø 9mm old edition		

flat-headed bolts

			
1			
GEV No.	560276	Ref. No.	503-405-140
description	flat-headed bolt thread M5 thread L 12mm SS DIN 84/ISO 1207 Qty 20 pcs intake slotted		

cylinder head bolts

DIN 912/ISO 4762



1

GEV No.	560025	Ref. No.	4001051934 511804120
description	cylinder head bolt thread M4 thread L 10mm WS 3 SS Qty 20 pcs DIN 912/ISO 4762		

washers

washers

miscellaneous



1

GEV No.	525307	Ref. No.	590715000
description	plain washer ID \varnothing 13mm ED \varnothing 22mm thickness 1.2mm SS Qty 1 pcs		

fasteners

retaining rings

DIN 472



1

GEV No.	528518	Ref. No.	568-101 000
description	retaining ring bore \varnothing 22mm thickness 1.2mm steel DIN 472		

DIN 6799



1

GEV No.	528709	Ref. No.	568204051
description	retaining ring ED1 \varnothing 4mm D2 \varnothing 9mm steel DIN 6799 thickness 0.7mm for shaft \varnothing 5-7mm		

B			
bi-metal thermostats		5, 5	
booster pumps II		9	
C			
cable glands		11, 11	
cables		11	
countersunk screws		21	
cylinder head bolts		22	
D			
dosing pumps		21	
E			
electric accessories		11	
electrodes		8	
F			
fasteners		22	
fastening material		21	
flat-headed bolts		21	
flow meters		9	
H			
heating elements		3	
heating elements for coffee machine		3	
hose connectors		21	
hoses		21	
I			
immersion heating elements		4	
indicator lights		6	
industrial hoses		21	
L			
lamps		6	
M			
microswitches		5	
motors		9	
O			
O-rings		18	
P			
pressure switches		8	
programme timers		6	
PTFE hoses		21	
pumps		9	
pumps for milk foamers		10	
R			
relays		6	
retaining rings		22	
rotary switches		5	
S			
safety thermostats		5	
screws		21	
sealing washers		19	
silicone hoses		21	
solenoid valves		7	
stainless steel flexi hoses		21	
supply hoses		21	
switches and momentary switches		5	
T			
thermostats		5	
timers		6	
touch sensitive light switches		6	
U			
universal hoses		21	
V			
vibration pumps		10	
W			
washers		22	